

Surface Mount Super Fast Recovery Rectifier

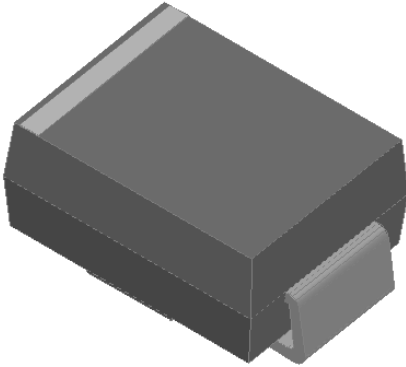

Features

- Low profile package
- Ideal for automated placement
- Glass passivated chip junction
- High forward surge capability
- Super Fast reverse recovery time
- Meets MSL level 1, per J-STD-020, LF maximum peak of 260 °C

Typical Applications

For use in high frequency rectification of power supplies, inverters, converters, and freewheeling diodes for consumer, and telecommunication.



Mechanical Data

- **Package:** DO-214AA (SMB)
Molding compound meets UL 94 V-0 flammability rating, RoHS-compliant, halogen-free
- **Terminals:** Tin plated leads, solderable per J-STD-002 and JESD22-B102
- **Polarity:** Cathode line denotes the cathode end

■ Maximum Ratings (T_a=25°C Unless otherwise specified)

PARAMETER	SYMBOL	UNIT	MURS320B	MURS340B	MURS360B
Device marking code			MURS320B	MURS340B	MURS360B
Maximum Repetitive Peak Reverse Voltage	V _{RRM}	V	200	400	600
Maximum RMS Voltage	V _{RMS}	V	140	280	420
Maximum DC blocking Voltage	V _{DC}	V	200	400	600
Average rectified output current @60Hz sine wave, resistance load, TL (Fig.1)	I _o	A	3.0		
Forward Surge Current (Non-repetitive) @60Hz Half-sine wave, 1 cycle, T _j =25°C	I _{FSM}	A	100		
Forward Surge Current (Non-repetitive) @1ms, square wave, 1 cycle, T _j =25°C			200		
Current squared time @1ms≤t≤8.3ms T _j =25°C	I ² t	A ² s	41.5		
Storage temperature	T _{stg}	°C	-55 ~ +150		
Junction temperature	T _j	°C	-55 ~ +150		



MURS320B THRU MURS360B

■ Electrical Characteristics (T_a=25°C Unless otherwise specified)

PARAMETER	SYMBOL	UNIT	TEST CONDITIONS	MURS320B	MURS340B	MURS360B
Maximum instantaneous forward voltage	V _F	V	I _{FM} =3.0A	0.92	1.25	
Maximum reverse recovery time	t _{rr}	ns	I _F =0.5A, I _R =1.0A, I _{rr} =0.25A	35	50	
Maximum DC reverse current at rated DC blocking voltage	I _R	μA	T _J =25°C	5		
			T _J =125°C	50		
Typical junction capacitance	C _j	pF	Measured at 1MHz and Applied Reverse Voltage of 4.0 V.D.C	63	55	50

■ Dynamic Characteristics

◆ MURS320B

PARAMETER	SYMBOL	UNIT	TEST CONDITIONS		Min	Typ	Max
Reverse Recovery Time	T _{RR}	ns	T _J =25°C	I _F =1A, di/dt=-50A/us V _{RM} =30V	-	30	-
			T _J =25°C	I _F =3A di/dt=-200A/us V _{RM} =100V	-	29	-
			T _J =125°C		-	35	-
Peak recovery current	I _{RRM}	A	T _J =25°C	I _F =3A di/dt=-200A/us V _{RM} =100V	-	3.8	-
			T _J =125°C		-	6.5	-
Reverse recovery charge	Q _{rr}	nC	T _J =25°C	I _F =3A di/dt=-200A/us V _{RM} =100V	-	39.9	-
			T _J =125°C		-	113.2	-
Non-repetitive avalanche energy	E _{AS}	mJ	T _J =25°C	I _R =3.6 A, L=15 mH	116.6	-	-

◆ MURS340B

PARAMETER	SYMBOL	UNIT	TEST CONDITIONS		Min	Typ	Max
Reverse Recovery Time	T _{RR}	ns	T _J =25°C	I _F =1A, di/dt=-50A/us V _{RM} =30V	-	40	-
			T _J =25°C	I _F =3A di/dt=-200A/us V _{RM} =200V	-	32	-
			T _J =125°C		-	52	-
Peak recovery current	I _{RRM}	A	T _J =25°C	I _F =3A di/dt=-200A/us V _{RM} =200V	-	4.8	-
			T _J =125°C		-	7.5	-
Reverse recovery charge	Q _{rr}	nC	T _J =25°C	I _F =3A di/dt=-200A/us V _{RM} =200V	-	76.5	-
			T _J =125°C		-	196.6	-
Non-repetitive avalanche energy	E _{AS}	mJ	T _J =25°C	I _R =0.8 A, L=15 mH	4.8	-	-

◆ MURS360B

PARAMETER	SYMBOL	UNIT	TEST CONDITIONS		Min	Typ	Max
Reverse Recovery Time	T _{RR}	ns	T _J =25°C	I _F =1A, di/dt=-50A/us V _{RM} =30V	-	48	-
			T _J =25°C	I _F =3A di/dt=-200A/us V _{RM} =400V	-	47	-
			T _J =125°C		-	71	-
Peak recovery current	I _{RRM}	A	T _J =25°C	I _F =3A di/dt=-200A/us V _{RM} =400V	-	5.9	-
			T _J =125°C		-	9.0	-
Reverse recovery charge	Q _{rr}	nC	T _J =25°C	I _F =3A di/dt=-200A/us V _{RM} =400V	-	138.1	-
			T _J =125°C		-	319.6	-
Non-repetitive avalanche energy	E _{AS}	mJ	T _J =25°C	I _R =0.8 A, L=15 mH	4.8	-	-



MURS320B THRU MURS360B

■ Thermal Characteristics (T_a=25°C Unless otherwise specified)

PARAMETER	SYMBOL	UNIT	MURS320B	MURS340B	MURS360B
Typical Thermal resistance	R _{θJ-A} ⁽¹⁾	°C/W	60		
	R _{θJ-L} ⁽¹⁾		20		
	R _{θJ-C} ⁽¹⁾		18		

Note:
 (1) Thermal resistance from junction to ambient and from junction to lead mounted on P.C.B. with 0.3" x 0.3" (8.0 mm x 8.0 mm) copper pad areas

■ Characteristics (Typical)

FIG.1: I_o-T_L Curve

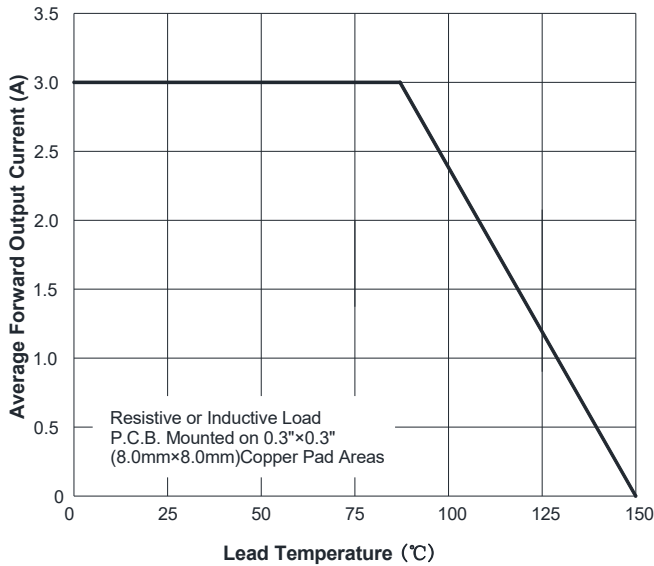

FIG.2: Forward Surge Current Capability

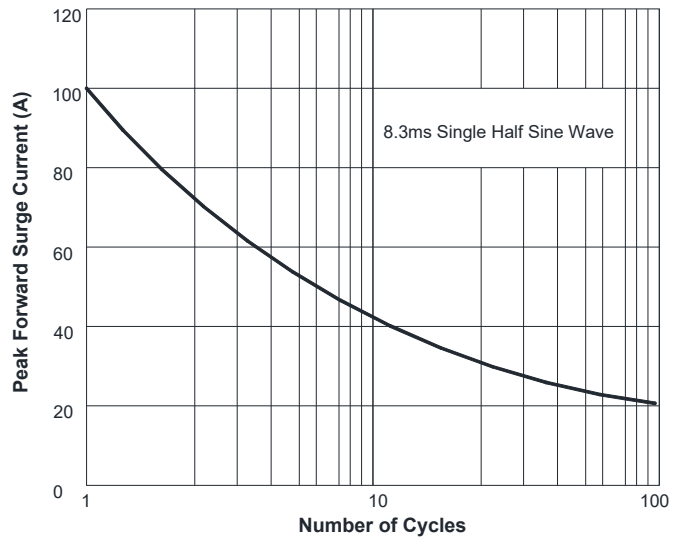

FIG.3: Typical Forward Voltage

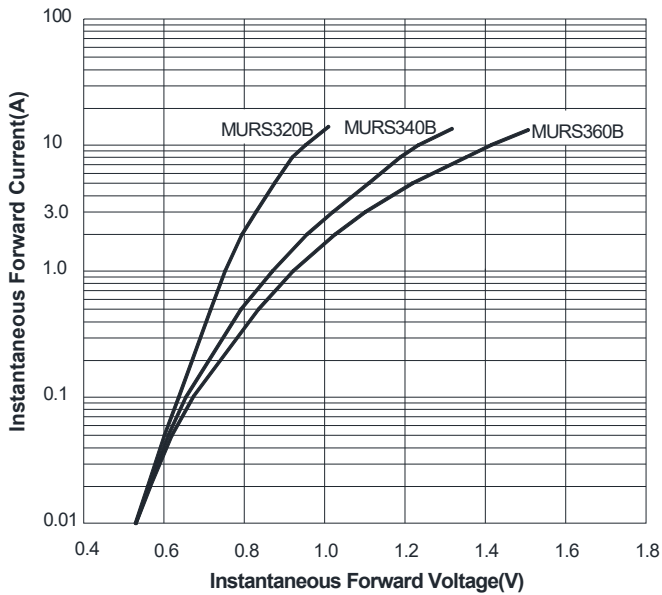
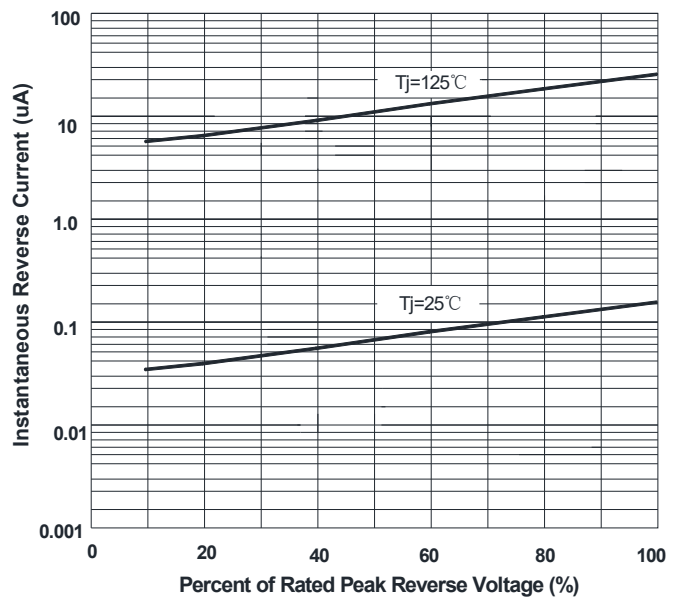

FIG.4: Typical Reverse Characteristics





MURS320B THRU MURS360B

FIG.5: Diagram of circuit and Testing wave form of reverse recovery time

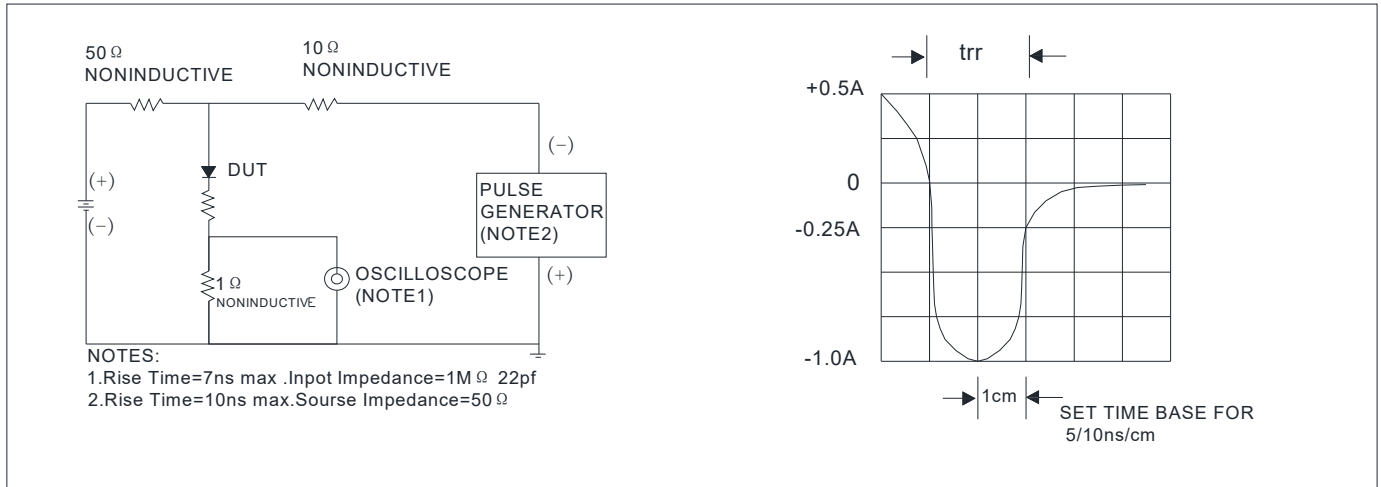

Ordering Information (Example)

PREFERED P/N	PACKING CODE	UNIT WEIGHT(g)	MINIMUM PACKAGE(pcs)	INNER BOX QUANTITY(pcs)	OUTER CARTON QUANTITY(pcs)	DELIVERY MODE
MURS320B-MURS360B	F1	Approximate 0.096	3000	/	48000	13" reel
MURS320B-MURS360B	F2	Approximate 0.096	750	6000	24000	7" reel
MURS320B-MURS360B	F3	Approximate 0.096	500	4000	16000	7" reel

Outline Dimensions

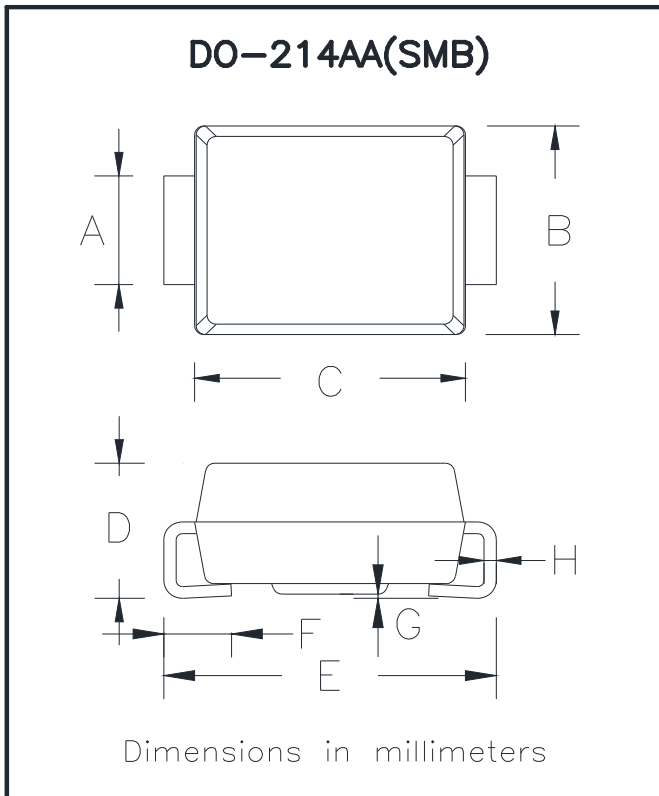

DO-214AA(SMB)		
Dim	Min	Max
A	1.85	2.15
B	3.30	3.94
C	4.05	4.75
D	1.99	2.61
E	5.21	5.59
F	0.90	1.41
G	0.05	0.20
H	0.15	0.31



MURS320B THRU MURS360B

■ Suggested pad layout

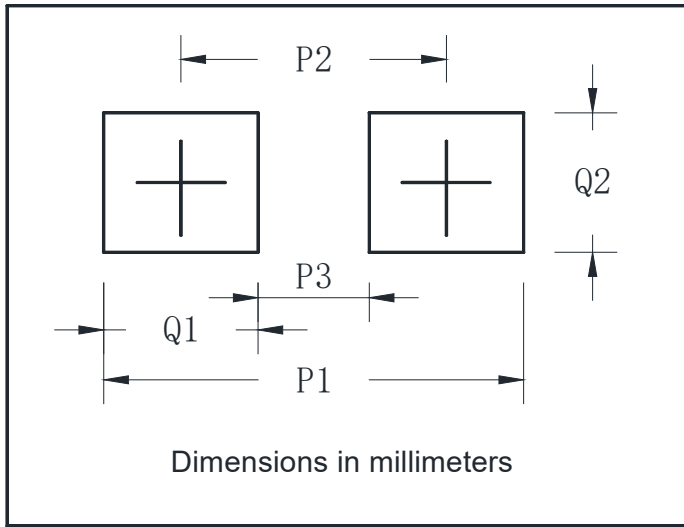

DO-214AA(SMB)	
Dim	Millimeters
P1	6.8
P2	4.3
P3	1.8
Q1	2.5
Q2	2.3



MURS320B THRU MURS360B

Disclaimer

The information presented in this document is for reference only. Yangzhou Yangjie Electronic Technology Co., Ltd. reserves the right to make changes without notice for the specification of the products displayed herein to improve reliability, function or design or otherwise.

The product listed herein is designed to be used with ordinary electronic equipment or devices, and not designed to be used with equipment or devices which require high level of reliability and the malfunction of which would directly endanger human life (such as medical instruments, transportation equipment, aerospace machinery, nuclear-reactor controllers, fuel controllers and other safety devices), Yangjie or anyone on its behalf, assumes no responsibility or liability for any damages resulting from such improper use of sale.

This publication supersedes & replaces all information previously supplied. For additional information, please visit our website [http:// www.21yangjie.com](http://www.21yangjie.com) , or consult your nearest Yangjie's sales office for further assistance.